



ANIMAL MANAGEMENT AND CONTROL

30
YEARS

30 years of designing and
manufacturing innovative
electric fencing solutions

NEMTEK
Electric Fencing Products



introduction

NEMTEK... A PIONEER IN ITS FIELD

The Nemtek group manufactures a full range of energizers and fencing hardware and has become a globally known and well respected company.

Nemtek's electric fencing solutions have become the products of choice. This has been achieved by Nemtek's continuous innovation, fast response to ever-changing market needs, the reliability of its products and its continuous support, service and close working relationship with its clients.

This brochure offers you an overview of the electric fencing products that Nemtek designs and manufactures for the Agricultural, Equine and Pet markets, which include a comprehensive range of energizers and a complete range of fencing hardware. The Nemtek range addresses many types of fencing needs, ranging from small enclosures to large farms and game reserves.

Nemtek's experience in the security field has revolutionised the way game farm and animal farm energizers are designed. Not only does Nemtek keep animals safely enclosed, but they now also offer security experience and communication techniques to combat the theft of animals by poachers.

For more details and information on Nemtek's products visit www.nemtek.com

THE REASONS FOR USING AN ELECTRIC FENCE

A high-voltage shock with a physical barrier will deter animals from leaving a controlled environment and venturing out. Wild animal and vermin movement can also be controlled by either keeping them inside a controlled area or outside and separate from another group of animals.

Electric fencing is more affordable than most conventional and traditional barriers in controlling animals. Electric fencing is easily transported. The shock also keeps the animals away from the fence, reducing damage to the fence. Portable fences can be erected quickly and smaller areas can be demarcated for grazing rotations.

NEMTEK SERVICE SUPPORT

Nemtek offers a free support and advice service that includes:

- expert advice on the design of your fence and choice of hardware
- assistance with the choice of energizer
- fault finding and correct earthing assistance.

agriculture

Nemtek's extensive range of quality and innovative Agricultural electric fencing products help ensure the safety and wellbeing of your animals.

Nemtek's Agricultural energizers are designed to suit the needs of various property sizes, from small hobby farms, larger farming properties, stud and cattle farms, to the larger stations. The Nemtek range of products is robustly designed and manufactured from top quality materials to ensure longevity and peak performance.

The Agricultural range of fencing products will help keep your animals safe and secure, providing you with peace of mind.



equine



Nemtek's wide range of Equine products are specifically designed and manufactured, taking into consideration the safety and wellbeing of your horses. The solutions Nemtek offers will suit the needs of any type of Equine farm, be it professional or a simple lifestyle farm.

The Equine range of fencing products will withstand the elements due to the robust designs and top quality materials used to manufacture these products.

Using Nemtek's Equine fencing systems gives you peace of mind, knowing your horse is safe from unwanted predators and free from injury from rusted barbed wire. The colours used in Nemtek's Equine range are highly visible to horses, thus reducing accidents.

Traditionally, electric fence energizers for animal farming control did not have a fence monitor to detect a break in the fence.

The detecting feature has become an integral part of game and animal control. It allows you to monitor the condition of the fence at the energizer without having to patrol the fence regularly, thus saving time and money.

Poaching is an additional problem faced by game reserves and game farms, but the security features with the audible alarm offered by the Nemtek electric fencing energizers can assist with this.



pet

Nemtek's state-of-the-art PetStop kit is designed to keep animals away from flowerbeds, veggie patches and refuse areas. It also acts as a barrier to protect your pet from other animals and helps to ensure a safe environment.

The great thing about the Nemtek PetStop kit is that it is fully solar powered and comes complete with an energizer, solar panel, battery, mounting bracket, fibreglass poles, earth spike, spring clamps, 200m of polywire and a warning sign.



contents

ENERGIZERS	6	FENCING POSTS AND BRACKETS	30
MAINS AND BATTERY MAINS WITH BATTERY BACK-UP OR SOLAR SOLAR WITH INTERNAL BATTERY SOLAR AND BATTERY ENERGIZER SELECTION TABLE		TEMPORARY AND SEMI-PERMANENT FIBREGLASS SPRING CLIPS WALL TOP BRACKETS OFFSET BRACKETS AND OUTRIGGERS FREE-STANDING SYSTEM	
PET KIT	15	GATE SYSTEMS	36
PETSTOP KIT		GATE HARDWARE	
FENCE TESTERS	16	GENERAL ACCESSORIES	37
FENCE SCOPE MULTI TOOL FENCE METER EASY FENCE TESTER		FENCE ACCESSORIES EARTH SPIKES	
INSULATOR RANGE	18	ENERGIZER ENCLOSURES	38
PORCELAIN INSULATORS PLASTIC INSULATORS PLASTIC INSULATOR – MULTI-FUNCTION TAPE INSULATORS – WOODEN POST PICKET CAPS		SOLAR POWER	39
FENCING WIRES, CABLES AND ACCESSORIES	22	SOLAR PANELS SOLAR REGULATOR MOUNTING BRACKETS	
WIRE, ROPE AND TAPE ELECTRIC FENCE NETTING CABLES (HT CABLES) WIRE, TAPE, ROPE AND CABLE CONNECTORS WIRE, ROPE AND TAPE DISPENSERS FENCING TOOLS WIRE TENSIONING SYSTEMS		BATTERIES AND BATTERY BOXES	40
		BATTERIES BATTERY BOXES	
		GETTING STARTED WITH ELECTRIC FENCING	41
		FENCE FAULT-FINDING CHART	45

GENERAL INFORMATION

WARRANTIES

Energizer electronics come with a two-year warranty, subject to our standard terms and conditions as set out on the Nemtek website.

COMPLIANCE

Nemtek energizers and products conform to the standards set out by the IEC 60355-2-76, CISPR 14 and EN 6100. Please refer to the energizer section of the Nemtek website for more details (www.nemtek.com).

SPECIFICATIONS

Product details can change without prior notice. This brochure is for general information and marketing purposes only. Performance information is affected by component tolerances and settings. Variations are normal.

TERMS AND CONDITIONS OF SALE

Sales of all Nemtek products are done subject to our standard terms and conditions of sale and our distribution agreements. Nemtek terms and conditions of sale are available at all Nemtek branches.

Authorised distributors and representative offices are available around the world. Please contact us at exports1@nemtek.co.za for further information.

TRAINING COURSES

Nemtek offers training courses for beginners and advanced training on the principles of electric fencing, as well as training on all the products that it manufactures.

ENERGIZERS

ENERGIZER: MAINS AND BATTERY

The Agri range of energizers can be powered with a battery or by mains, making them convenient and adaptable depending on your needs. Most of the energizers use Nemtek Adaptive Power Technology (APT), which ensures maximum power is delivered to the electric fence while minimising power losses along the fence line. With APT the energizer responds to changing environmental factors (such as changes in weather and vegetation growth on the fence), and adapts to the changing needs of the fence by maximising fence power and efficiency.

 STORED ENERGY
  OUTPUT ENERGY



* 3km
0.5J
0.3J

PET 3 (AE-A/PET)

The Pet energizer is designed to keep pets out of specific areas such as flowerbeds, vegetable gardens and refuse areas:

- Powers up to 3km of fence wire* (up to 1km of fence wire in average conditions)
- Robust weather-resistant system
- Adaptable mounting options (wall, fence wire or wooden post)
- Output energy max 0.3J (stored energy 0.5J)
- Powered by battery or mains power adaptor (included)
- Lightning protection
- A solar panel PetStop kit is also available



APT
* 5km
0.8J
0.5J

AGRI 5 (AE-A005J)

- Powers up to 5km of fence wire* (up to 2km of fence wire in average conditions)
- Robust weather-resistant system
- Battery charge state indicator
- Energizer overload indicator
- Day/night sensor
- Output energy max 0.5J (stored energy 0.8J)
- Powered by battery or mains power adaptor (included)
- Adaptable mounting options (wall, fence wire or wooden post)
- Lightning protection
- Many programmable options via the LCD handheld programmer (optional accessory) including adjustment of fence voltage and pulse rate, independent day/night setting, battery voltage reporting and fence performance monitoring



APT
* 10km
1.65J
1J

AGRI 10 (AE-A010J)

- Powers up to 10km of fence wire* (up to 4km of fence wire in average conditions)
- Robust weather-resistant system
- Battery charge state indicator
- Energizer overload indicator
- Day/night sensor
- Output energy max 1J (stored energy 1.65J)
- Powered by battery or mains power adaptor (included)
- Adaptable mounting options (wall, fence wire or wooden post)
- Lightning protection
- Many programmable options via the LCD handheld programmer (optional accessory) including adjustment of fence voltage and pulse rate, independent day/night setting, battery voltage reporting and fence performance monitoring



- APT
- * 20km
- 3.3J
- 2J

AGRI 20 (AE-A020J) 

- Powers up to 20km of fence wire* (up to 6km of fence wire in average conditions)
- Robust weather-resistant system
- Battery charge state indicator
- Energizer overload indicator
- Day/night sensor
- Output energy max 2J (stored energy 3.3J)
- Powered by battery or mains power adaptor (included)
- Adaptable mounting options (wall, fence wire or wooden post)
- Lightning protection
- Many programmable options via the LCD handheld programmer (optional accessory) including adjustment of fence voltage and pulse rate, independent day/night setting, battery voltage reporting and fence performance monitoring



- APT
- * 20km
- 3.3J
- 2J

EQUINE 20 (AE-A/EQ) 

- Powers up to 20km of fence wire* (up to 6km of fence wire in average conditions)
- Robust weather-resistant system
- Battery charge state indicator
- Energizer overload indicator
- Day/night sensor
- Output energy max 2J (stored energy 3.3J)
- Powered by battery or mains power adaptor (included)
- Adaptable mounting options (wall, fence wire or wooden post)
- Lightning protection
- Includes LCD handheld programmer to programme and monitor energizer functions, such as adjustment of fence voltage and pulse rate, independent day/night setting, battery voltage reporting and fence performance monitoring

* The distances that can be powered are a guideline only and apply to optimal fence conditions. Factors such as the resistance of the fence wire, the type of fence wire, the installation of the fence, proximity of the live fence wire to other earth wires, the amount of vegetation touching the fence and earthing of the fence system will influence the distance that can be powered. For more information please refer to www.nemtek.com



- APT
- * 30km
- 4.4J
- 3J

AGRI 30 (AE-A030J)

- Powers up to 30km of fence wire* (up to 9km of fence wire in average conditions)
- Robust weather-resistant system
- Battery charge state indicator
- Energizer overload indicator
- Day/night sensor
- Output energy max 3J (stored energy 4.4J)
- Powered by battery (sold separately) or mains power adaptor (included)
- Adaptable mounting options (wall, fence wire, wooden post and also slides onto Y-picket post)
- Lightning protection
- Many programmable options via the LCD handheld programmer (optional accessory) including adjustment of fence voltage and pulse rate, independent day/night setting, battery voltage reporting and fence performance monitoring



- APT
- * 50km
- 6.5J
- 4.6J

AGRI 50 (AE-A050J)

- Powers up to 50km of fence wire* (up to 15km of fence wire in average conditions)
- Robust weather-resistant system
- Battery charge state indicator
- Energizer overload indicator
- Day/night sensor
- Output energy max 4.6J (stored energy 6.5J)
- Powered by battery (sold separately) or mains power adaptor (included)
- Adaptable mounting options (wall, fence wire, wooden post and slides onto Y-picket post)
- Lightning protection
- Many programmable options via the LCD handheld programmer (optional accessory) including adjustment of fence voltage and pulse rate, independent day/night setting, battery voltage reporting and fence performance monitoring



MAINS POWER ADAPTOR 12VDC (AEE-A/CHR, AEE-A/CHR/AU)

- 240V charger for energizers
- Plugs into energizer and mains 240V when available
- European and Australian plugs



AGRI ENERGIZER TREAD-IN POST (AA-AETP)

The tread-in post holds the Agri energizers off the ground and can also be used as an earth spike. It is mostly used in temporary and portable fencing environments.

- The curved handle is used to push the tread-in post into the ground and remove the post from the ground
- Hot-dip galvanised so it can be used as an earth spike
- Fits and supports all Nemtek portable energizers
- Robust construction for multiple uses and a long life



ENERGIZER: MAINS WITH BATTERY BACK-UP OR SOLAR

The Druid 114 LCD single-zone energizer is the ideal choice for long-distance, parallel electric fencing systems that require monitoring such as game farms, animal parks, cattle farms and nature reserves. This energizer is ideal for controlling game and wild animals such as elephants, lions, tigers, rhino, buffalo, bears, warthog, hippo, buck and deer.

Using the Adaptive Power Technology (APT), pioneered by Nemtek, this energizer offers a new and unique method in detecting how much power a fence can accept and handle before it starts to arc and waste energy, thus maximising the power on the fence.



APT

* 130km

21J

13.8J

DRUID 114 (E-DRUID/114/LCD)



DRUID KEYPAD (OPTIONAL EXTRA) (EE-DR.LCD/KP)

- Large energizer powers up to 130km of fence wire* (up to 40km of fence wire in average conditions)
- Ideal choice for long fences that require monitoring
- Built-in alarm that sounds if there is fence tampering or a fence fault
- LCD display makes information quick and easy to read
- Easy-to-use tag switch included for controlling the energizer
- Output energy max 13.8J (stored energy 21J)
- Powered by 220V mains and includes built-in battery for back-up power
- 140 watt solar panels and external 12V 140Watt Nemtek regulator with a larger 100Ah battery that can be added when mains power is not available (not included)
- Adaptable mounting options (wall or cabinet)
- Lightning protection
- The energizer can also be programmed and controlled remotely by adding up to two keypads

* The distances that can be powered are a guideline only and apply to optimal fence conditions. Factors such as the resistance of the fence wire, the type of fence wire, the installation of the fence, proximity of the live fence wire to other earth wires, the amount of vegetation touching the fence and earthing of the fence system will influence the distance that can be powered. For more information please refer to www.nemtek.com

ENERGIZER: SOLAR WITH INTERNAL BATTERY

The Agri solar energizers include an attached large solar panel and a built-in environmentally friendly Lithium iron battery (LiFe). The environmentally friendly battery offers a much longer life span than traditional lead-acid batteries. These Agri solar energizers with the advanced battery technology are ready to use and easy to install. They are used for small distance fences (only SB Range).



LiFe
BATTERY

*
1km

5W
SOLAR
PANEL

0.125J
0.1J

AGRI 1 SOLAR (AE-SB001)

- Powers up to 1km of fence wire* (up to 0.4km of fence wire in average conditions)
- Large 5W solar panel for quick charge
- Robust solar bracket and weather-resistant housing
- On/off TAG to switch the energizer on and off
- Output energy max 0.1J (stored energy 0.125J)
- Battery charge state indicator
- Solar panel charge state indicator
- Deep sleep mode for battery safe-mode storage
- Day/night sensor
- Y-picket mounting
- Lightning protection



LiFe
BATTERY

*
3km

5W
SOLAR
PANEL

0.33J
0.26J

AGRI 3 SOLAR (AE-SB003)

- Powers up to 3km of fence wire* (up to 1km of fence wire in average conditions)
- Large 5W solar panel for quick charge
- Robust solar bracket and weather-resistant housing
- On/off TAG to switch the energizer on and off
- Output energy max 0.26J (stored energy 0.33J)
- Battery charge state indicator
- Solar panel charge state indicator
- Deep sleep mode for battery safe-mode storage
- Day/night sensor
- Y-picket mounting
- Lightning protection



LiFe
BATTERY

*
5km

10W
SOLAR
PANEL

0.55J
0.47J

AGRI 5 SOLAR (AE-SB005)

- Powers up to 5km of fence wire* (up to 2km of fence wire in average conditions)
- Large 10W solar panel for quick charge
- Robust solar bracket and weather-resistant housing
- On/off TAG to switch the energizer on and off
- Output energy max 0.47J (stored energy 0.55J)
- Battery charge state indicator
- Solar panel charge state indicator
- Deep sleep mode for battery safe-mode storage
- Day/night sensor
- Y-picket mounting
- Lightning protection

2-YEAR
factory
warranty
on battery



1. Large solar panel for quick charge
2. Robust solar mounting bracket
3. Robust weather-resistant housing
4. Mountable onto a Y-picket. Can also be used as an earth (hot-dip galvanised)
5. Heavy-duty screw-on knobs
6. Energizer status indicator
7. Battery charge status indicator
8. Solar panel charge state indicator
9. Internal environmentally friendly LiFe battery



LiFe
BATTERY

*
8km

10W
SOLAR
PANEL

0.825J
0.68J

AGRI 8 SOLAR (AE-SB008)

- Powers up to 8km of fence wire* (up to 3km of fence wire in average conditions)
- Large 10W solar panel for quick charge
- Robust solar bracket and weather-resistant housing
- On/off TAG to switch the energizer on and off
- Output energy max 0.68J (stored energy 0.825J)
- Battery charge state indicator
- Solar panel charge state indicator
- Deep sleep mode for battery safe-mode storage
- Day/night sensor
- Y-picket mounting
- Lightning protection

ENERGIZER: SOLAR AND BATTERY

The Agri solar range of energizers includes a solar panel, which is used to charge a battery during the day to power the energizer. Solar panels are usually provided with a separate solar regulator, but the Nemtek Agri solar range of energizers has a built-in solar regulator. This makes the energizer more portable and makes connecting of the energizer easier. The built-in regulator has a smart management system to maximise battery life and ensure efficient power management to the fence. These energizers also come with built-in polarity protection for the battery and the solar system to protect them in the event of an incorrect connection. The energizers use Nemtek Adaptive Power Technology (APT), which ensures maximum power is delivered to the electric fence while minimising power losses along the fence line. With APT the energizer responds to changing environmental factors (such as changes in weather and vegetation growth on the fence), and adapts the changing needs of the fence to maximise fence power and efficiency.



AGRI 10 SOLAR (AE-S010)



- Powers up to 10km of fence wire* (up to 4km of fence wire in average conditions)
- Robust weather-resistant system
- Battery charge state indicator
- Energizer overload indicator
- Output energy max 1J (stored energy 1.4J)
- Powered by 10 watt solar panel (included) and 12Ah battery (sold separately)
- Built-in solar regulator with power management system for easier connection and portability
- Built-in battery polarity protection
- Day/night sensor
- Y-picket mounting
- Lightning protection
- Many programmable options via the LCD handheld programmer (optional accessory) including adjustment of fence voltage and pulse rate, independent day/night setting, battery voltage reporting and fence performance monitoring

APT

* 10km

10W
SOLAR
PANEL

1.4J
1J



AGRI 25 SOLAR (AE-S025)



- Powers up to 25km of fence wire* (up to 8km of fence wire in average conditions)
- Robust weather-resistant system
- Battery charge state indicator
- Energizer overload indicator
- Output energy max 2.3J (stored energy 3.1J)
- Powered by 20 watt solar panel (included) and 28Ah battery (sold separately)
- Built-in solar regulator with power management system for easier connection and portability
- Built-in battery polarity protection
- Day/night sensor
- Y-picket mounting
- Lightning protection
- Many programmable options via the LCD handheld programmer (optional accessory) including adjustment of fence voltage and pulse rate, independent day/night setting, battery voltage reporting and fence performance monitoring

APT

* 25km

20W
SOLAR
PANEL

3.1J
2.3J



AGRI 50 SOLAR (AE-S050)



- Powers up to 50km of fence wire* (up to 15km of fence wire in average conditions)
- Robust weather-resistant system
- Battery charge state indicator
- Energizer overload indicator
- Output energy max 4.6J (stored energy 6.5J)
- Powered by 40 watt solar panel (included) and 50Ah battery (sold separately)
- Built-in solar regulator with power management system for easier connection and portability
- Built-in battery polarity protection
- Day/night sensor
- Angle-adjustable solar mounting bracket included (mounting pole not included)
- Y-picket mounting
- Lightning protection
- Many programmable options via the LCD handheld programmer (optional accessory) including adjustment of fence voltage and pulse rate, independent day/night setting, battery voltage reporting and fence performance monitoring



LCD ENERGIZER PROGRAMMER (AE-A/KCREM)

The Agri energizers can also be programmed and have their power and efficiency levels monitored using the LCD energizer programmer. This programmer allows you to perform and monitor a number of fence functions when you use it with the energizer. Some of the functions that can be monitored or programmed using the programmer are:

- Adjusting fence voltage
- Adjusting pulse rate
- Independent day/night setting of fence voltage and pulse rate
- Fence voltage control that can be switched between conventional and APT methods
- Adjusting energizer overload warning threshold
- Accurate battery voltage reporting
- Nemtek security lock energizer theft deterrent
- Memory of lowest-recorded fence voltage
- Memory of highest-recorded energizer effort



TAG (EE-WIZ4/MAGNET)

- Switches the energizer on and off
- Fits onto a keyring
- Included and used with the
 - AGRI 30, AGRI 50 mains energizers
 - AGRI 1 SOLAR, AGRI 3 SOLAR, AGRI 5 SOLAR, AGRI 8 SOLAR (internal battery)
 - AGRI 10 SOLAR, AGRI 25 SOLAR, AGRI 50 SOLAR
 - DRUID 114 energizers

ENERGIZER SELECTION TABLE

MAINS AND BATTERY							
MODEL	PET	Agri 5	Agri 10	Agri 20	Equine 20	Agri 30	Agri 50
Product code	AE-A/PET	AE-A005J	AE-A010J	AE-A020J	AE-A/EQ	AE-A030J	AE-A050J
Fence-wire length (optimal conditions)	3km	5km/ 7 acres/2.8ha	10km/ 16 acres/6.4ha	20km/ 32 acres/12.8ha	20km/ 32 acres/12.8ha	30km/ 50 acres/20ha	50km/ 80 acres/32ha
Fence-wire length (average conditions)	1km	2km/ 2.8 acres/1.2ha	4km/ 7 acres/2.6ha	6km/ 19 acres/4ha	6km/ 19 acres/4ha	9km/ 15 acres/6ha	15km/ 24 acres/10ha
Stored energy (Joules)	0.5J	0.8J	1.65J	3.3J	3.3J	4.4J	6.5J
Maximum output energy (Joules)	0.3J	0.5J	1.0J	2.0J	2.0J	3.0J	4.6J
Voltage output circuit	7.5kV	8.5kV	9kV	9kV	9kV	9kV	9kV
Voltage output @ 1 000 Ω	4kV	4kV	6.5kV	6.5kV	6.5kV	8.5kV	8.5kV
APT technology included	No	Yes	Yes	Yes	Yes	Yes	Yes
Main power adaptor 12VDC	Included	Included	Included	Included	Included	Included	Included
Battery (AGM) 12VDC (sold separately, battery leads included)	2.2Ah = 30 hours	7Ah = 108 hours	7Ah = 54 hours	7Ah = 42 hours	7Ah = 42 hours	28Ah = 96 hours	50Ah = 96 hours
Remote LCD display energizer programmer	No	Optional	Optional	Optional	Yes included	Optional	Optional
Keyring on/off tag	No	No	No	No	No	Yes	Yes
Day/night sensor	No	Yes	Yes	Yes	Yes	Yes	Yes
Mounting options	Wall, fence wire, wooden post, tread-in post	Wall, fence wire, wooden post, tread-in post	Wall, fence wire, wooden post, tread-in post	Wall, fence wire, wooden post, tread-in post	Wall, fence wire, wooden post, tread-in post	Wall, fence wire, wooden post, Y-picket post	Wall, fence wire, wooden post, Y-picket post
Internal lightning protection	Yes	Yes	Yes	Yes	Yes	Yes	Yes

MODEL	SOLAR INTERNAL BATTERY				SOLAR EXTERNAL BATTERY			MAINS WITH BATTERY BACK-UP OR SOLAR
	Agri 1 Solar	Agri 3 Solar	Agri 5 Solar	Agri 8 Solar	Agri 10 Solar	Agri 25 Solar	Agri 50 Solar	
Product code	AE-SB001	AE-SB003	AE-SB005	AE-SB008	AE-S010	AE-S025	AE-S050	E-DRUID/114/LCD
Fence-wire length (optimal conditions)	1km	3km	5km	8km	10km/16 acres/6.4ha	25km/40 acres/16ha	50km/80 acres/32ha	130km/200 acres/82ha
Fence-wire length (average conditions)	0.4km	1km	2km	3km	4km/ 7 acres/2.6ha	8km/ 12 acres/5ha	15km/ 24 acres/10ha	40km/ 60 acres/25ha
Stored energy (Joules)	0.12J	0.33J	0.55J	0.82J	1.4J	3.1J	6.5J	21J
Maximum output energy (Joules)	0.1J	0.26J	0.47J	0.68J	1.0J	2.3J	4.6J	13.8J
Voltage output circuit	7.1kV	10kV	12kV	12kV	8kV	9kV	9kV	9kV
Voltage output @ 1 000 Ω	3.7kV	5kV	6kV	6.4kV	7.5kV	8.5kV	8.5kV	8.5kV
APT technology included	No	No	No	No	Yes	Yes	Yes	Yes
Solar panel size	5 watt	5 watt	10 watt	10 watt	10 watt	20 watt	40 watt	Can also be solar powered
Battery	LiFe internal	LiFe internal	LiFe internal	LiFe internal	12Ah	28Ah	50Ah	Includes a 7Ah battery
Remote LCD display energizer programmer	No	No	No	No	Optional	Optional	Optional	Keypad optional
Keyring on/off tag	Yes	Yes	Yes	Yes	Yes	Yes	Yes	Yes
Day/night sensor	Yes	Yes	Yes	Yes	Yes	Yes	Yes	No
Mounting options	Wall, fence wire, wooden post, tread-in post	Wall, fence wire, wooden post, tread-in post	Wall, fence wire, wooden post, tread-in post	Wall, fence wire, wooden post, tread-in post	Wall, fence wire, wooden post, tread-in post	Wall, fence wire, wooden post, tread-in post	Y-picket post	Wall or cabinet type
Internal lightning protection	Yes	Yes	Yes	Yes	Yes	Yes	Yes	Yes

* The distances that can be powered are a guideline only and apply to optimal fence conditions. Factors such as the resistance of the fence wire, the type of fence wire, the installation of the fence, proximity of the live fence wire to other earth wires, the amount of vegetation touching the fence and earthing of the fence system will influence the distance that can be powered. For more information please refer to www.nemtek.com.

PET KIT

PetStop KIT (AA-PET/KIT)

A complete user-friendly kit used to keep pets out of areas such as flowerbeds and refuse areas. The 24m kit is powered by a battery and solar panel. Accessories are available for larger fencing needs.



PetStop EARTH SPIKE
(EA-EAG/PET)



EARTH CLAMP CABLE



24 X 8MM SPRING CLIPS
(AA-PS/SPR/8R)



WARNING SIGN
(EA-WRS2/N)

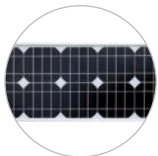

3W REGULATED SOLAR PANEL
(SOL-SYS3W/PS)



12V-2AH BATTERY
(BAT-B02)



PET ENERGIZER
(AE-A/PET)

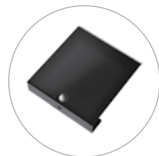

ENERGIZER, BATTERY AND SOLAR PANEL MOUNTING BRACKET
(AA-PSB)



200M POLYWIRE ECOSTOP SS3
(AW-PWSS3/200M)



8 X FIBREGLASS RODS (8MM X 850MM)
(AA-FR/8/850)

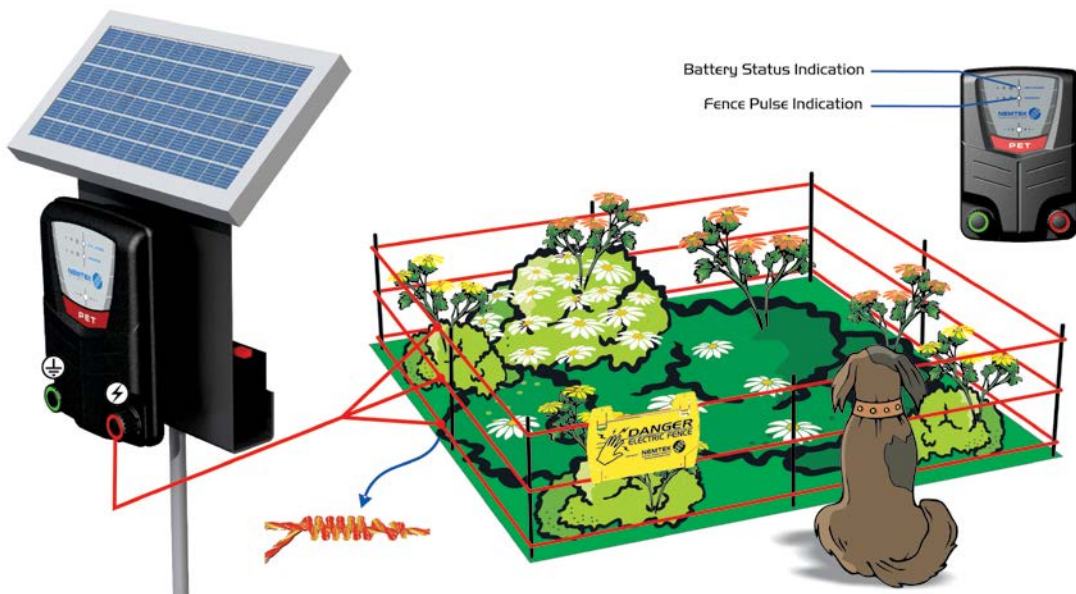

FENCE TESTERS

FENCE SCOPE MULTI TOOL (TL-FS)



The Fence Scope is a 4-in-1 tool, which helps diagnose problems on your fence to optimise electric fence installation and ensure that the fence continues to operate at ideal levels.

There are four operation modes to select from:

- **Fence probe mode** – quickly indicates the direction of a fence fault, showing the voltage and current.
- **Fence energy mode** – accurately measures the output energy along the fence. This mode can be used to test the size of the shock the animal will receive at any point along the fence by simulating the animal. This helps to ensure that the voltage and the energy is sufficient along the entire fence to deliver an appropriate shock to the animal.
- **Fence scope mode** – this can record and display waveforms of the electric fence pulse. Distortions in the waveform (wave shape) generally indicate that there are fence faults.
- **Fence noise mode** – this shows the amount of electromagnetic interference generated by the fence or energizer. This feature assists in finding cracked or broken insulators, sparks and shorts along the fence.



FENCE METER (TL-FM)



The Nemtek Fence Meter helps diagnose problems on your fence to optimise the electric fence installation and ensure that the fence operates at an ideal level.

FEATURES:

- Patented fence probe offers more accurate readings
- Quickly and easily locates faults along the fence line
- Large display for easy reading
- Displays current, voltage and the direction of a fault
- Lightweight with a convenient belt clip
- Slimline, rugged design with a water-resistant case
- Low battery warning
- Automatic energizer-polarity detection
- Can be used with most energizers



EASY FENCE TESTER (TL-EFT)

The frequency of the flashing LEDs will change as the voltage increases or decreases. The slower the flashing rate the lower the voltage. The intensity of the light remains the same so it can be seen from far irrespective of the fence voltage. It is installed between the earth and live wire to indicate the status and condition of the fence for peace of mind.







FEATURES:

- Includes clips to connect to wire or polytape
- Indicates power on the fence for peace of mind
- Visible from up to 1km at night and 100m during the day
- No batteries required
- Uses minimal power from the fence
- The frequency of the flashing LEDs indicates the amount of energy on the fence. The longer the period between flashes, the lower the voltage on the fence
- Highly visible LEDs allow for a 160-degree viewing angle. This allows the light to shine into the secure area only
- Can operate from 0.9kV to 12kV
- Can be used with most electric fence energizers











INSULATOR RANGE















PORCELAIN INSULATORS

	<p>BOBBIN – PORCELAIN (EI-BPFL)</p> <ul style="list-style-type: none"> • Fireproof and long lasting • Large design to reduce power loss 	
	<p>STRAIN – PORCELAIN (EI-STFP)</p> <ul style="list-style-type: none"> • Fireproof and long lasting • Large design to reduce power loss • Suitable for long runs • Can withstand high tension 	
	<p>BOBBIN INSULATOR CLIP (AA-PIFC)</p> <ul style="list-style-type: none"> • Galvanised steel clip with nut and bolt • Fastens the bobbin – porcelain and the tension bobbin insulator onto the Y-picket 	





PLASTIC INSULATORS

	<p>TENSION BOBBIN INSULATOR (EI-BTL)</p> <ul style="list-style-type: none"> • Heavy-duty large insulator • Used with offset bracket where fire is not a concern • Black 	
	<p>STRAIN INSULATOR – ULTRA (EI-STB/R, EI-STW/R)</p> <ul style="list-style-type: none"> • Suitable for fences using up to 2mm wire • Larger tracking distance to reduce arcing • Suitable for medium-tensioned fences • Black or white 	
	<p>STRAIN INSULATOR – HARDENED ULTRA (EI-STB/R/H, EI-STW/R/H)</p> <ul style="list-style-type: none"> • Suitable for fences using up to 3mm wire • Larger tracking distance to reduce arcing • Suitable for high-tensioned fences • Black or white 	
	<p>PICKET INSULATOR (EI-PI)</p> <ul style="list-style-type: none"> • Used with Nemtek Y-picket (for the Iscor Y-standard use the EI-YB insulator) • Double tracking fin to reduce arcing • Quick-fit design clip • Black 	







* All plastic insulators are UV stabilised for long life.

	<p>Y STANDARD INSULATOR (EI-YB)</p> <ul style="list-style-type: none"> • Used with Iscor Y-standard (for the Nemtek Y-picket use the EI-PI insulator) • Quick-fit design – easy to replace when required • Black 	
	<p>NAIL-ON INSULATOR (EI-NOB, EI-NOW)</p> <ul style="list-style-type: none"> • Large clips for thicker wires • Larger clearance to eliminate power leakage • Black or white 	
	<p>THICK WIRE-AND-ROPE INSULATOR (AI-TWRI/B, AI-TWRI/W)</p> <ul style="list-style-type: none"> • Heavy duty • Suitable for thick wire or polyrope (6mm) • Can be screwed or nailed into post • Black or white 	
	<p>RING INSULATOR SCREW 40MM (AI-RI40)</p> <ul style="list-style-type: none"> • Screw into wooden post • Large clearance to eliminate power leakage • Black 	
	<p>RING INSULATOR LONG-ARM SCREW 190MM (AI-RI/L190)</p> <ul style="list-style-type: none"> • Screw into wooden post • 190mm long arm • Black 	
	<p>SCREW-ON INSULATOR (AI-SOB)</p> <ul style="list-style-type: none"> • Screw onto round bar • Fits 8mm–12mm round bar • Black 	
	<p>GUM-POLE SLEEVE (AA-SP/WI)</p> <ul style="list-style-type: none"> • Insulated tube inner diameter (4.5mm) and thick external diameter (10mm) • 10m roll • Black 	





PLASTIC INSULATOR – MULTI-FUNCTION

	<p>DUAL PIN PICKET INSULATOR (AI-DPI)</p> <ul style="list-style-type: none"> • Used with the Y-picket • Multi-function: can secure 12mm, 20mm, 40mm polytape, polyrope and steel wires • Large design for heavy-duty use • Black 					
						

TAPE INSULATORS – WOODEN POST

	<p>END AND CORNER POST INSULATOR (AI-CI/PT/B, AI-CI/PT/W)</p> <ul style="list-style-type: none"> • Used to secure the equine electric fence polytape in place • To be used at the beginning, end, and when the equine fence changes direction • Suitable for 12mm, 20mm and 40mm tape • Black or white 	
	<p>INTERMEDIATE POST INSULATOR (AI-I/PT/B, AI-I/PT/W)</p> <ul style="list-style-type: none"> • Rubber pad to secure tape and increase life span • Used to secure the electric fence polytape in place • Suitable for straight runs • Black or white 	
	<p>WOODEN POST TAPE INSULATOR (AI-TI)</p> <ul style="list-style-type: none"> • Screw into wooden post • Suitable for 20mm and 40mm tape • Black 	

PICKET CAPS

	<p>PICKET CAP ROPE AND WIRE (AA-P/CAP/ROPE)</p> <ul style="list-style-type: none"> • Suitable for all polyropes and wires • Heavy-duty design • Fits most types of pickets and Y-posts • White for high visibility 		
<p>ROPE WITH 40MM TAPE</p>	<p>ROPE WITH 20MM TAPE</p>	<p>ROPE WITH ROPE</p>	
			



PICKET CAP FOR STEEL POST [AA-P/CAP]

- Can be used with steel wire, 12mm, 20mm, 40mm tape, and 6mm rope
- Heavy-duty design
- Fits most types of pickets and Y-posts
- White for high visibility



40MM TAPE WITH ROPE



40MM TAPE WITH 20MM TAPE



40MM TAPE SYSTEM



FENCING WIRES, CABLES AND ACCESSORIES

WIRE, ROPE AND TAPE

● GOOD VOLTAGE ● LOW VOLTAGE

		VOLTAGE AT START OF FENCE	VOLTAGE AT 200m	VOLTAGE AT 500m	VOLTAGE AT 2 000m	VOLTAGE AT 5 000m
	<p>POLYWIRE ECOSTOP SS3 (AW-PWSS3/200M)</p> <ul style="list-style-type: none"> Available in 200m roll For small, short fences 3 stainless steel conductors 13 300 Ω/km Strength 40kg (±10%) 	8 500	1 340	590	300	60
	<p>POLYWIRE VARIO SS6 (AW-PWSS6/400M)</p> <ul style="list-style-type: none"> Available in 400m roll For small, short fences 6 stainless steel conductors 4 000 Ω/km Strength 64kg (±10%) 	8 500	3 260	1 700	940	200
	<p>POLYWIRE BLUE MIX3</p> <ul style="list-style-type: none"> Available in 200m (AW-PWB MIX3/200M) and 400m (AW-PWB MIX3/400M) rolls For small- to medium-sized fences 3 stainless steel and conductive strands for better electrical conductivity 380 Ω/km Strength 80kg (±10%) 	8 500	7 370	6 150	4 830	1 770
	<p>POLYWIRE BLUE MIX6 (AW-PWB MIX6/400M)</p> <ul style="list-style-type: none"> Available in 400m roll For medium- to large-sized fences 6 stainless steel and conductive strands for better electrical conductivity 190 Ω/km Strength 90kg (±10%) 	8 500	7 900	7 140	6 150	2 930
	<p>POLYWIRE ULTRA MIX9 3.5mm (AW-PWUL9/200M)</p> <ul style="list-style-type: none"> Available in 200m roll For medium- to large-sized fences 9 stainless steel and conductive strands for better electrical conductivity 110 Ω/km Strength 155kg (±10%) 	8 500	8 140	7 650	6 960	5 900
	<p>POLY BRAID MIX6 3.5mm (AW-PBR MIX6/550)</p> <ul style="list-style-type: none"> Available in 550m roll (spooled in 400m and 150m) For medium- to large-sized fences 6 stainless steel and conductive strands for better electrical conductivity 154 Ω/km Strength 134kg (±10%) 	8 500	8 000	7 360	6 490	5 260

		VOLTAGE AT START OF FENCE	VOLTAGE AT 200m	VOLTAGE AT 500m	VOLTAGE AT 2 000m	VOLTAGE AT 5 000m
	POLY BRAID ULTRA MIX11 (AW-PBUL11/200M) <ul style="list-style-type: none"> Available in 200m roll For medium- to large-sized fences 11 stainless steel and conductive strands for better electrical conductivity 110 Ω/km Strength 225kg (±10%) 	8 500	8 140	7 650	6 960	5 900
	POLYROPE WHITE MIX6 (AW-PRBMIX6/200M) <ul style="list-style-type: none"> Available in 200m roll High visibility For medium- to large-sized fences 6 stainless steel and highly conductive strands for better electrical conductivity 190 Ω/km Strength 410kg (±10%) 	8 500	7 900	7 140	6 150	2 930
	POLYROPE BLACK MIX6 (AW-PRBMIX6/200B) <ul style="list-style-type: none"> Available in 200m roll For medium- to large-sized fences 6 stainless steel and conductive strands for better electrical conductivity 190 Ω/km Strength 410kg (±10%) 	8 500	8 140	7 650	6 960	5 900
	POLY ROPE ULTRA MIX9 6mm (AW-PRUL9/200M) <ul style="list-style-type: none"> Available in 200m roll For medium- to large-sized fences 9 stainless steel and conductive strands for better electrical conductivity 120 Ω/km Strength 550kg (±10%) 	8 500	8 110	7 580	6 850	5 740
	POLYTAPE MIX 12mm <ul style="list-style-type: none"> Available in 200m (AW-PTMX12MM/200) and 400m (AW-PTMX12MM/400) rolls Bright blue for high visibility to animals 5 stainless steel and highly conductive strands for better electrical conductivity 180 Ω/km Strength 112kg (±10%) 	8 500	7 920	7 200	6 250	3 030
	POLYTAPE MIX 20mm <ul style="list-style-type: none"> Available in 200m (AW-PTMX20MM/200) and 500m (AW-PTMX20MM/500) rolls 20mm tape: white and blue for higher visibility 6 stainless steel and highly conductive strands for better electrical conductivity 170 Ω/km Strength 150kg (±10%) 	8 500	7 960	7 260	6 340	3 140

		VOLTAGE AT START OF FENCE	VOLTAGE AT 200m	VOLTAGE AT 500m	VOLTAGE AT 2 000m	VOLTAGE AT 5 000m
	<p>POLYTAPE MIX 40mm (AW-PTM40MM/200)</p> <ul style="list-style-type: none"> Available in 200m roll 40mm high visibility to horses Thick plastic edges to increase life and reduce wear 8 stainless steel and highly conductive strands for better electrical conductivity 160 Ω/km Strength 190kg (±10%) Available in 316 stainless steel – 1 540 Ω/km (AW-PT40/316/200) 	8 500	7 900	7 320	6 430	3 270
	<p>FLEXI ROPE 8mm (AA-EEC/50M)</p> <ul style="list-style-type: none"> Available in 50m roll Flexible conductive rope that can be used in gateways UV stabilised for long life Expands up to twice its original length 					
	<p>ALUMINIUM SOLID WIRE 2mm/500m (AW-AL20/500)</p> <ul style="list-style-type: none"> Ideal for permanent fencing Easy to join and lightweight Excellent electrical conductivity for longer fencing Good corrosion resistance 14 Ω/km Strength 96kg (±10%) 	8 500	8 450	8 380	8 040	7 450
	<p>ALUMINIUM STRANDED WIRE 2mm/500m (AW-AL20/500/STR)</p> <ul style="list-style-type: none"> Reusable for portable and temporary fencing Easy to join, flexible and lightweight Good corrosion resistance 18 Ω/km Strength 65kg (±10%) 	8 500	8 430	8 350	7 920	7 200
	<p>SOLID GALVANISED HIGH-TENSILE WIRE 2.24mm</p> <ul style="list-style-type: none"> Standard medium-galvanised finish (EW-G2.24) Heavy-galvanised finish (EW-G2.24HG) Available in 50kg rolls (1 650m) Available in 25kg rolls (825m) Ideal for permanent fencing 50 Ω/km Strength 450kg (±10%) 	8 500	8 330	8 100	7 080	5 670
	<p>STRANDED GALVANISED WIRE XL</p> <ul style="list-style-type: none"> Available in 1.6mm (EW-T16/XL) 1 560m rolls and 2mm (EW-T20/XL) 1 000m rolls Excellent corrosion resistance Good electrical conductivity for longer fencing Easy-to-work-with stranded wire Its high tensile strength makes it harder to cut 1.6mm@100 Ω/km; 2.0mm@60 Ω/km Strength 1.6mm 200kg, 2mm 300kg (+/-10%) 	8 500	8 300	8 000	7 000	5 500

* All polytape, polyrope, polybraid and polywires are UV stabilised for long life. The voltage values shown along the fence are based on a single-wire fence with a load of 500 Ω to simulate and represent an animal touching the fence. The earth conditions are assumed to be perfect for the comparative voltage values shown above.

ELECTRIC FENCE NETTING

SHEEP AND GOAT (AA-NET108)

- Heavy-duty UV-stabilised polywires
- 3 x 0.20mm stainless steel conductors per horizontal fence line
- A total of 9 horizontal fence lines of which 8 are electrified. The bottom wire is not electrified as it touches the ground
- Metal clip to join multiple nets together
- Two-pronged metal foot for stability
- Repair kit and corner-post tie-downs included
- Multiple nets are easily connected



POULTRY (AA-NET112)

- Heavy-duty UV-stabilised polywires
- 3 x 0.20mm stainless steel conductors per horizontal fence line
- A total of 12 horizontal fence lines of which 11 are electrified. The bottom wire is not electrified as it touches the ground
- Metal clip to join multiple nets together
- Two-pronged metal foot for stability
- Repair kit and corner-post tie-downs included
- Multiple nets are easily connected



NEMTEK ENERGIZER MINIMUM REQUIREMENTS

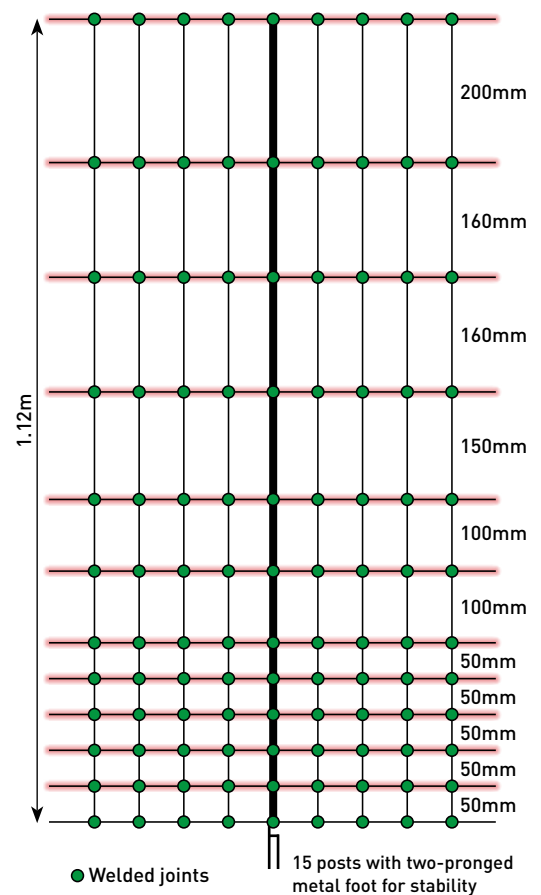
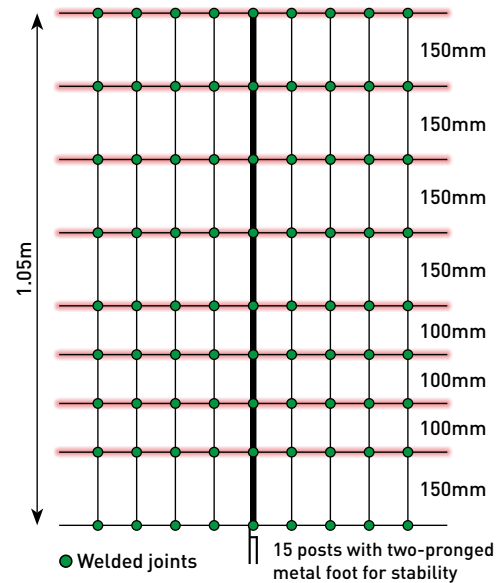

- For one net use a 0.25 joule energizer
- For two nets use a 0.50 joule energizer
- For three nets use a 0.75 joule energizer
- For four nets use a 1.0 joule energizer with APT
- For more than four and up to ten nets use a 2.5 joule energizer with APT

HEAVY DUTY RE-ENFORCED POSTS













CABLES (HT CABLES)

Nemtek offers a range of high-voltage cables to use with your energizer and for all other insulated high-voltage transmissions. The high-voltage cables have been designed for a long life expectancy and low resistance on permanent fencing systems in most weather conditions. All Nemtek high-voltage cables are double insulated.

	<p>CABLES (S-SERIES)</p> <ul style="list-style-type: none"> • Available in 30m (EH-BS030S) and 100m (EH-BS100S) • The S-Series high-voltage cables can be used with all the Nemtek polytape, polyrope, polybraid and polywires • Slimline design for ease of installation • Ideal for temporary fence systems
	<p>UNDERGATE CABLE (U-SERIES)</p> <ul style="list-style-type: none"> • The U-Series high-voltage cable is used with galvanised wires, aluminium wires and all polytape, polyrope, polybraid and polywires • Available in 1.6mm and 2.5mm heavy-galvanised inner conductor • 1.6mm/25m (AH-UC1.6/25) • 1.6mm/50m (AH-UC1.6/50) • 1.6mm/100m (AH-UC1.6/100) • 2.5mm/25m (AH-UC2.5/25) • 2.5mm/50m (AH-UC2.5/50) • 2.5mm/100m (AH-UC2.5/100) • 2.5mm/200m (AH-UC2.5/200) • 2.5mm/500m (AH-UC2.5/500)







WIRE, TAPE, ROPE AND CABLE CONNECTORS

	<p>LINE CLAMPS (EA-LC8/MG)</p> <ul style="list-style-type: none"> • The line clamps are used for the larger wire diameters • Can connect after the wire has been installed • 8mm mechanically galvanised for long life 	
	<p>CLAW CLAMP (EA-LC8/C)</p> <ul style="list-style-type: none"> • Can be utilised to change direction of wire • XL galvanised • Can be used for larger wire diameters • Can connect after wire is installed 	
	<p>JOINER BUCKLE (AA-J/PT)</p> <ul style="list-style-type: none"> • Joiner buckles are used to join 40mm polytapes • Zinc ensures a good electrical connection is maintained and ensures durability 	
	<p>TERMINATION BUCKLE (AA-B/PT)</p> <ul style="list-style-type: none"> • The termination buckle is used to connect 40mm polytape to the high tension cable (HT) coming from the energizer to terminate the fence • Zinc ensures a good electrical connection is maintained and ensures durability 	
	<p>ALUMINIUM FERRULE 10MM (EA-F10AFT)</p> <ul style="list-style-type: none"> • The aluminium ferrule is used to connect both the stranded and the solid aluminium wires • Good, permanent connection is ensured 	

WIRE, ROPE AND TAPE DISPENSERS











			
<p>REEL HOLDER GEARED 1:1 (AA-RH1)</p> <ul style="list-style-type: none"> Recommended for up to <ul style="list-style-type: none"> - 100m of 40mm tape - 200m of 20mm tape - 200m of 12mm tape - 200m of polywire - 200m of 2mm aluminium stranded wire 	<p>REEL HOLDER GEARED 3:1 (AA-RH2)</p> <ul style="list-style-type: none"> Geared 3:1 for easy spooling Recommended for up to <ul style="list-style-type: none"> - 100m of 40mm tape - 200m of 20mm tape - 400m of 12mm tape - 800m of polywire - 500m of 2mm aluminium stranded wire 	<p>LARGE WIRE DISPENSER (EW-JENNY)</p> <ul style="list-style-type: none"> Portable design For 2.2mm, 2.5mm and 3mm wire Up to 50kg roll coil dispenser 	<p>BRAIDED WIRE REEL HOLDER (EW-T/RH)</p> <ul style="list-style-type: none"> Hot-dip galvanised wire dispenser 12mm, 20mm and 40mm tape dispenser

FENCING TOOLS

		
<p>DRIVER TOOL 10MM ROD (TL-PD10R)</p> <ul style="list-style-type: none"> Used to drive 8mm and 10mm fibre and steel rods into the ground 	<p>DISTANCE MEASURING WHEEL (TL-DMW)</p> <ul style="list-style-type: none"> Quick, walk along distance-measuring tool 	<p>KNIPPEX WIRE CUTTER (TL-MN)</p> <ul style="list-style-type: none"> Designed for high-tensile wire cutting
		
<p>PROFESSIONAL CRIMPING TOOL (TL-CRP)</p> <ul style="list-style-type: none"> Durable ferrule crimping tool 	<p>HALF INCH RATCHET TENSIONER (TL-RAT1/2)</p> <ul style="list-style-type: none"> Used to tension the Hybrid combo tensioner 	<p>Y-STANDARD POST DRIVER (TL-PDY)</p> <ul style="list-style-type: none"> Used as a hammer to drive Y-standards into the ground

WIRE TENSIONING SYSTEMS



	<p>HEAVY-DUTY COMPRESSION SPRING (ES-CNT3)</p> <ul style="list-style-type: none"> • Can be used with any electric fencing wire • Stainless steel spring maintains constant tension on the fence • Engineered plastic material eliminates galvanic reaction between dissimilar metals, thus eliminating rust • Can be used with any type of wire 	
	<p>COMBO TENSIONER HYBRID (ES-CTNTBB)</p> <ul style="list-style-type: none"> • Can tension a 1.2mm to 2.5mm wire, making it very versatile • Engineered plastic material eliminates galvanic reaction between dissimilar metals, thus eliminating rust • Can be used with any type of wire 	
	<p>STANDARD TENSIONER (ES-DT)</p> <ul style="list-style-type: none"> • Galvanised, permanent fence wire strainer • Can tension a 1.2mm to 2.2mm wire • Only use with galvanised wires to avoid galvanic reaction 	
	<p>COMBO TENSIONER - STANDARD (ES-CTS)</p> <ul style="list-style-type: none"> • Galvanised, permanent fence wire strainer with built-in insulator (plastic) • Can tension a 1.2mm to 2.2mm wire • Only use with galvanised wires to avoid galvanic reaction 	
	<p>COMBO TENSIONER - PORCELAIN (ES-CTP)</p> <ul style="list-style-type: none"> • Galvanised, permanent fence wire strainer with built-in insulator (porcelain) • Can tension a 1.2mm to 2.2mm wire • Only use with galvanised wires to avoid galvanic reaction 	
	<p>WIRE STRAINER - HEAVY DUTY (AS-WS/HD)</p> <ul style="list-style-type: none"> • Galvanised, permanent fence wire strainer • Can tension a 1.6mm to 3mm wire • Only use with galvanised wires to avoid galvanic reaction 	
	<p>WIRE STRAINER - INSULATED PLASTIC - HEAVY DUTY (AS-WSI/HD)</p> <ul style="list-style-type: none"> • Galvanised, permanent fence wire strainer with built-in insulator (hardened plastic) • Can tension a 1.6mm to 3mm wire • Only use with galvanised wires to avoid galvanic reaction 	
	<p>WIRE STRAINER - PORCELAIN - HEAVY DUTY (AS-WSP/HD)</p> <ul style="list-style-type: none"> • Galvanised, permanent fence wire strainer with built-in insulator (porcelain) • Can tension a 1.6mm to 3mm wire • Only use with galvanised wires to avoid galvanic reaction 	

	<p>WIRE STRAINER COMBO BLACK BD (AS-WSI/BD)</p> <ul style="list-style-type: none"> • Working force of up to 450kg • UV-stabilised insulated tensioner • No galvanic reaction between wires and tensioner • Steel wire diameters up to 3mm 	
	<p>WIRE STRAINER COMBO BLUE BD (AS-WSI/BBD)</p> <ul style="list-style-type: none"> • Working force of up to 150kg • UV-stabilised insulated tensioner • No galvanic reaction between wires and tensioner • Polywires diameter up to 10mm 	
	<p>S-HOOK (ES-HK/EP)</p> <ul style="list-style-type: none"> • Hot-dip galvanised for long life expectancy • Heavy-duty durable design • Suitable for angled and rounded-corner poles 	
	<p>THROUGH HOLE S-HOOK (ES-HK/THR/HDG)</p> <ul style="list-style-type: none"> • Hot-dip galvanised for long life expectancy • Heavy-duty durable design 	
	<p>U-HOOK (ES-HK/UH304)</p> <ul style="list-style-type: none"> • Stainless steel hook for long life expectancy • Heavy-duty durable design 	







FENCING POSTS AND BRACKETS

TEMPORARY AND SEMI-PERMANENT FENCING POSTS

 <p>1 500mm 1 250mm 1 000mm 850mm</p>	 <p>1 200mm 200mm</p>	 <p>1 310mm 1 060mm 200mm Galvanised finish</p>
<p>FIBREGLASS POST</p> <ul style="list-style-type: none"> • Available in 8mm x 850mm (AA-FR/8/850) • Available in 10mm x 1 000mm (AA-FR/10/1000) • Available in 10mm x 1 250mm (AA-FR/10/1250) • Available in 10mm x 1 500mm (AA-FR/10/1500) 	<p>TREAD-IN POST (PLASTIC)</p> <ul style="list-style-type: none"> • Available in white (AA-PP/W) for visibility. 1 200mm total length • Available in black (AA-PP/B) for higher UV protection. 1 200mm total length • 8 clip positions for up to 40mm of polytape, polyrope, polybraid and polywires • Galvanised steel spike • UV stabilised for long life 	<p>PIGTAIL STEEL POST</p> <ul style="list-style-type: none"> • 8mm steel, powder-coated white for high visibility • Available in 1 060mm total length (AA-PT/800W) • Available in 1 310mm total length (AA-PT/1050W) • Galvanised (AA-PT/800/G, AA-PT/1050/G)

FIBREGLASS SPRING CLIPS

	<p>SPRING CLIP 8MM (AA-PS/SPR/8R)</p> <ul style="list-style-type: none"> • For 8mm fibreglass post • Stainless steel for long life 	
	<p>SPRING CLIP 10MM - GOLD (AA-SPR/10R)</p> <ul style="list-style-type: none"> • For 10mm fibreglass post • Stainless steel for long life 	



WALL TOP BRACKETS

	<p>SIDE MOUNT BRACKET – SINGLE WIRE (E-TW/1WSM/P)</p> <ul style="list-style-type: none"> • Heavy-duty design • Hot dip and powder coated finish • Can be electrified using any Nemtek energizer
	<p>WALL TOP BRACKET – SINGLE WIRE (E-TW/1WS)</p> <ul style="list-style-type: none"> • Heavy-duty design • Hot dip and powder coated finish • Can be electrified using any Nemtek energizer
	<p>WALL TOP BRACKET – THREE WIRE (E-TW/3WS)</p> <ul style="list-style-type: none"> • Heavy-duty design • Hot dip and powder coated finish • Can be electrified using any Nemtek energizer
	<p>WALL TOP BRACKET – FIVE WIRE (AA-MOD5W)</p> <ul style="list-style-type: none"> • Modular design to fit most wall top needs • Durable fibre glass for most harsh environments • Insulator can be installed on both sides of the fence



OFFSET BRACKETS AND OUTRIGGERS

Offset brackets utilise the strength and rigidity of an existing fence, reducing costs of the electric fence system. They are generally used for animal control and are available in 4mm galvanised high-tensile steel.



LIVE AND EARTH HORIZONTAL OFFSET BRACKET (TRIPLE)

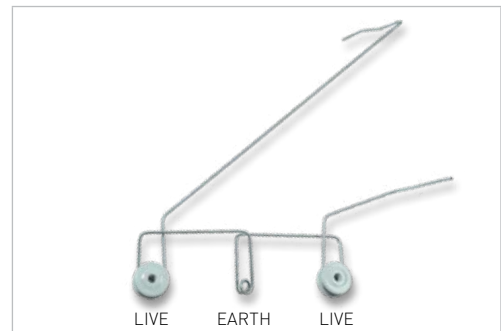

ANTI-DIG OFFSET BRACKET (EY-OAD)

- The triple wire bracket is placed near the bottom of the fence in order to stop animals from crawling or digging under the fence line

LIVE AND EARTH WIRE OFFSET (DOUBLE OR TRIPLE OFFSET)

The live and earth wire offsets are designed to carry a live and earth wire along the fence line. These are ideal for areas where earth conditions are not good. Ideal for long fencing systems.

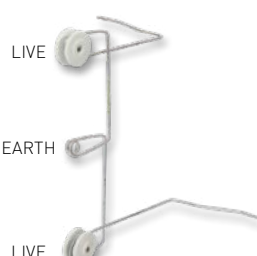
	
<ul style="list-style-type: none"> Offset double – 225mm (EY-OD225) (excludes insulator) Offset double – 350mm (EY-OD350) (excludes insulator) 	<ul style="list-style-type: none"> Offset triple – 240mm (EY-OT240) (excludes insulator)

LIVE WIRE OFFSET AND OUTRIGGER (SINGLE WIRE)

The single-wire offset and the outrigger brackets are used to carry the live wire along the fence. The outrigger comes with a built-in insulator (EI-PI). The offset wire can be used with the porcelain insulator bobbin (EI-BPFL) or the tension bobbin insulator (EI-BTL).

	
<ul style="list-style-type: none"> Outrigger single – 230mm (AA-OUTRIGGER230) (includes insulator) Outrigger single – 340mm (AA-OUTRIGGER340) (includes insulator) 	<ul style="list-style-type: none"> Offset single – 225mm (EY-OS225) (excludes insulator) Offset single – 450mm (EY-OS450) (excludes insulator)

LIVE TIP OFFSET BRACKETS

The live tip offset brackets are available in a single or a double wire construction. The bracket itself is also live, stopping anyone touching the bracket and protecting it from tampering and damage. The live tip bracket can be fastened onto any existing Y-picket or wooden posts. The heavy duty plastic body of the live tip insulates the bracket from the Y-picket or wooden post.

FENCING BRACKET OFFSET – SINGLE LIVE TIP

[AA-YP/LIVE/S]

- Heavy-duty design for harsh environments
- Discourages jumping and climbing over the fence line when placed at the top of a fence
- Digging under the fence line is reduced when the double offset is placed at the bottom of the fence line
- Quick to install with a nut and bolt which is included
- No sharp edges
- No extra insulator required

Specifications

Size: 285mm

Material: 6mm high-tensile steel and plastic

Finish: heavy galvanised

Insulated hard and durable body

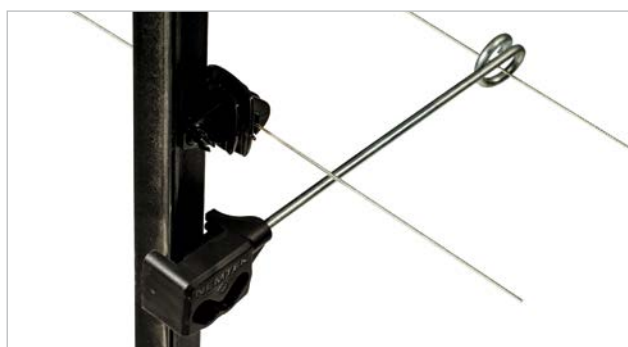

FENCING BRACKET OFFSET – DOUBLE LIVE TIP

[AA-YP/LIVE/D]

- Double live tips in one bracket
- Heavy-duty design for harsh environments
- Discourages jumping and climbing over the fence line when placed at the top of a fence
- Digging under the fence line is reduced when the double offset is placed at the bottom of the fence line
- Quick to install with a nut and bolt which is included
- No sharp edges
- No extra insulator required

Specifications

Size: 570mm

Material: 6mm high-tensile steel and plastic

Finish: heavy galvanised

Insulated hard and durable body



FREE-STANDING SYSTEM

INTERMEDIATE POSTS

Nemtek has a range of products available to set up a free-standing electric fence. These include corner posts and end posts for tensioning the fence and intermediate posts for guiding the wires between the posts.

INTERMEDIATE POSTS (Y-PICKETS)						
	Nemtek picket intermediate posts	Number of wires	Number of holes	Fence height	Finish	Associated insulators
	Nemtek Y-picket – 1.5m Bitumen (EY-Y15NB) Hot-dip galvanised (EY-Y15NHD)	Up to 11	11 100mm spacing	1.2m	Bitumen or hot-dip galvanised	Picket insulator (EI-PI)
	Nemtek Y-picket – 2.4m Bitumen (EY-Y24NB) Hot-dip galvanised (EY-Y24NHD)	Up to 20	20 100mm spacing	2.0m	Bitumen or hot-dip galvanised	Picket insulator (EI-PI)
	Nemtek Y-picket – 3.0m Bitumen (EY-Y30NB) Hot-dip galvanised (EY-Y30NHD)	Up to 24	24 100mm spacing	2.4m	Bitumen or hot-dip galvanised	Picket insulator (EI-PI)

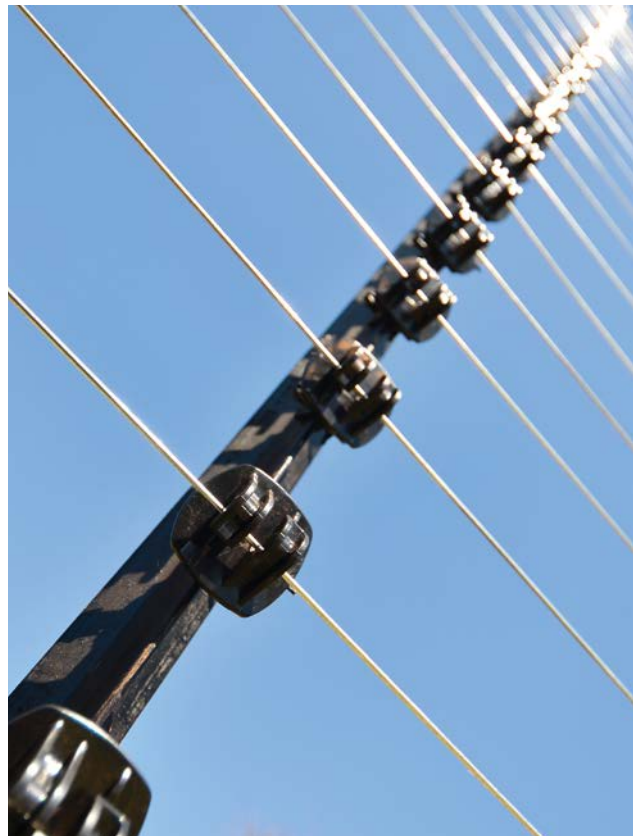

CORNER, END POSTS AND ASSOCIATED STAYS



CORNER, END POSTS AND ASSOCIATED STAYS						
	Round-corner and end-straining posts	Number of wires	Number of holes	Fence height	Finish	Associated stays
Nut (EA-SCRM10NUTSHD) Bolt (EA-SCRM10X120H)	Round tube 76 x 2mm/2.4m (EY-CPR762HD24)	20	2 x 20	2.0m	Hot-dip galvanised	Round 38 x 2mm/2.4m (EY-CSR3824HD)
	Round tube 76 x 2mm/3.0m (EY-CPR762HD30)	24	2 x 24	2.4m	Hot-dip galvanised	Round 50 x 2mm/3.0m (EY-CSR5030HD)
	Round tube 95 x 2mm/2.4m (EY-CPR9520HD24)	20	2 x 20	2.0m	Hot-dip galvanised	Round 50 x 2mm/2.4m (EY-CSR5024HD)
	Round tube 95 x 2mm/3.0m (EY-CPR9520HD30)	24	2 x 24	2.4m	Hot-dip galvanised	Round 50 x 2mm/3.0m (EY-CSR5030HD)

Black powder-coated finish available to order





GATE SYSTEMS

GATE HARDWARE





			
<p>INSULATED HANDLE WITH HOOK (EA-GH/B)</p> <ul style="list-style-type: none"> • UV-stabilised gate handle • Non-slip grip 	<p>PLASTIC GATE HANDLE (EA-GH/P)</p> <ul style="list-style-type: none"> • UV-stabilised gate handle • Non-slip grip 	<p>GALVANISED SPRING 3.5M (EA-GS/W)</p> <ul style="list-style-type: none"> • Used together with the insulated handle with hook to secure a gate up to 3.5m 	<p>GATE HANDLE WITH SPRING (EA-GH/BS)</p> <ul style="list-style-type: none"> • Used to secure a gate opening up to 1.5m • UV stabilised
			
<p>3-WAY GATE CONNECTOR (AA-AT/PT3/GAS)</p> <ul style="list-style-type: none"> • 3 different connection points for flexibility • UV-stabilised plastic • Galvanised for long life • Bolt for fastening high-voltage cable 	<p>TAPE GATE HANDLE KIT (AA-GHT4)</p> <ul style="list-style-type: none"> • Used with Equine fencing • White and blue tape for higher visibility • UV stabilised • Suitable for up to 4m gate openings 	<p>FLEXI GATE HANDLE KITS</p> <p>Available for:</p> <ul style="list-style-type: none"> • 3.5m to 7m gate openings (AA-FGS/1) • 5.5m to 11m gate openings (AA-FGS/2) • Stretchable flexicord contains stainless steel strands for conductivity • High-visibility warning sign 	

GENERAL ACCESSORIES

FENCE ACCESSORIES

		
<p>WARNING SIGNS (EA-WRS2/N)</p> <ul style="list-style-type: none"> • Custom-made warning signs are available on order • Wire clips on the warning sign reduce installation time 	<p>FENCE LIGHT – TIMED</p> <ul style="list-style-type: none"> • The frequency of the flashing LEDs indicates the voltage level on the fence. The longer the period between flashes, the lower the voltage on the fence • Fence light galvanised wire (inland use) (SR-FL/TL/G) • Fence light stainless steel wire (coastal use) (SR-FL/TL/SS) • Install it on your electric fence to indicate power status for peace of mind • Installed between any earth and live wires 	<p>CUT-OUT SWITCH (AA-COS)</p> <ul style="list-style-type: none"> • Isolates a section of the fence to allow for easy maintenance and fault finding
		
<p>FLOODGATE CONTROLLER (AA-FGC)</p> <ul style="list-style-type: none"> • Limits energy on a section of fence in areas where flooding or heavy growth occurs 	<p>LIGHTNING PROTECTION (EA-LID)</p> <ul style="list-style-type: none"> • Lightning protection system inhibits lightning and diverts the voltage spikes caused by lightning • Stainless steel components for long life 	<p>ENERGIZER CONNECTOR CLIPS</p> <ul style="list-style-type: none"> • Insulated battery clips with leads (black and red pair) (AEE-CL/BR) • Insulated fence clips with leads (green and red pair) (AEE-CL/GR)

EARTH SPIKES

			
<p>HOT-DIP GALVANISED 1M LONG (EA-EAG1)</p>	<p>HOT-DIP GALVANISED 1.2M LONG (EA-EAG12)</p>	<p>COPPER-CLAD 1M LONG (EA-EAN)</p>	<p>COPPER-CLAD 1.2M LONG (EA-EAN/L)</p>
<ul style="list-style-type: none"> • Hot-dip galvanised or copper-clad earth spikes with nuts and washers • Available in both 1.0m and 1.2m lengths • Earthing kit available for use in areas where the earthing conditions are not good. These kits include a conductive earth compound • The double nut and washer allow for a good electrical connection with the HT cables 			

ENERGIZER ENCLOSURES



ALUMINIUM BOX (ENC-ALU/S)

- Internal dimensions: (h) 610 x (w) 450 x (d) 260mm
- External dimensions: (h) 640 x (w) 450 x (d) 310mm
- Medium capacity to house an energizer, solar regulator and a deep-cycle battery
- Ventilated aluminium box



ALUMINIUM BOX (ENC-ALU)

- Internal dimensions: (h) 610 x (w) 800 x (d) 300mm
- External dimensions: (h) 640 x (w) 800 x (d) 350mm
- Ventilated aluminium box
- Large capacity to house double energizers, solar regulator and deep-cycle batteries
- Available in shock box version (ENC-SHBOX)



ALUMINIUM BOX (ENC-ALU/XL)

- Internal dimensions: (h) 760 x (w) 800 x (d) 300mm
- External dimensions: (h) 790 x (w) 800 x (d) 350mm
- Ventilated aluminium box
- Large capacity to house double energizers, solar regulator and deep-cycle batteries
- Available in shock box version (ENC-SHBOXXL)



ENCLOSURE STANDS

- Hot-dip galvanised stands for the aluminum enclosures
- Optional U-bracket (ENC-KDS/UBOLT) is required when creating a concrete base
- Stands 1 180mm high off the ground
- Available in two sizes. Small enclosure stand (ENC-KDS/S) and a larger enclosure stand (ENC-KDS)

ENCLOSURE STAND U-BRACKET (ENC-KDS/UBOLT)

- Use with concrete to secure the enclosure stand into the ground



SOLAR POWER

SOLAR PANELS

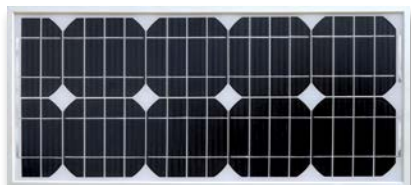

Nemtek solar panels offer a reliable source of power for electric fence systems in remote areas or where AC power supply is unreliable.

Module characteristics	AE-SOL-SYS10W 1/10 units	AE-SOL-SYS20W 1/8 units	AE-SOL-SYS40W 1/4 units	SOL-SYS90W 1/2 units	SOL-SYS140W 1 units
Maximum power (Pmax)	10 watt	20 watt	40 watt	90 watt	140 watt
Open-circuit voltage (Voc)	21.6V	21.6V	21.6V	21.6V	21.6V
Weight	0.6kg	2.6kg	4.2kg	8kg	11.5kg
Module dimensions	384 x 252 x 30mm	520 x 360 x 30mm	610 x 510 x 30mm	970 x 670 x 35mm	1 516 x 670 x 35mm

SOLAR REGULATOR (SOL-REG140)



The LED solar regulator offers advanced MPP technology for over 90% efficiency when used with a 140Watt solar panel. It can also be used with solar panels sizes from 20Watt to 200Watts making it very flexible. Larger than the 140Watt solar panels can be used in areas where sunlight intensity is low increasing the capture of sunlight.

- Power-handling capability 140W
- Solar panel input range 20W ~ 200W
- Maximum load supply current 10A
- The LED display indicates and shows solar charge, battery condition and load indication
- Set to operate as a 12VDC system
- The regulator is equipped with various devices to protect its electronics
- Battery charge voltage Flooded, AGM, Gel Suitable lead-acid battery types 14.3VDC

MOUNTING BRACKETS (SY-SYZ040R)



Quick and easy to install onto most of Nemtek's solar panels.

- Adjustable angle: 15, 30 and 45 degrees
- Use on panel: 20W, 40W, 90W and 140W
- Made from extruded aluminium with stainless steel fasteners

BATTERIES AND BATTERY BOXES

BATTERIES



Battery characteristics	BAT-B07 1/5 units	BAT-B12 1/4 units	BAT-B28 1/2 units	BAT-B50 1 unit	BAT-B100 1 unit
Nominal voltage	12V	12V	12V	12V	12V
Nominal capacity	7Ah	12Ah	28Ah	50Ah	100Ah
Type	Sealed rechargeable battery				
Weight	2.15kg	3.4kg	9kg	16kg	29.8kg
Dimensions (L x W x H in mm)	151 x 65 x 95	151 x 99 x 101	175 x 165 x 126	229 x 138 x 213	329 x 172 x 218

BATTERY BOXES

BATTERY BOX 50Ah (BAT-B50/BOX)

- Battery box with a 50Ah battery will allow you to have portable 12V power for a range of outdoor uses
- Outdoor protection for the 50Ah battery
- Strong and sturdy design
- 280mm (L) x 190mm (W) x 240mm (H)
- UV stabilised for long life



BATTERY BOX 100Ah (BAT-B100/BOX)

- Battery box with a 100Ah battery will allow you to have portable 12V power for a range of outdoor uses
- Outdoor protection for the 100Ah battery
- Strong and sturdy design
- 410mm (L) x 238mm (W) x 263mm (H)
- UV stabilised for long life



GETTING STARTED WITH ELECTRIC FENCING

HOW AN ELECTRIC FENCE WORKS

In order for a fence to shock an animal an electrical circuit needs to be completed. The energizer sends a high-voltage pulse through the fence live wires. The energizer needs to be earthed.

When the animal touches the live wire, the pulse will flow from the live fence wires to the animal, then into the earth, and back to the energizer, completing the circuit. The completion of the circuit delivers a safe yet memorable, sudden and quick shock to the animal.

The shock creates an unpleasant memory that animals generally recall. Different animals may require different levels of voltage to create the appropriate shock depending on the thickness of their coats or hides. Sheep, goats and wild animals generally require higher voltage levels compared to horses, pigs and cows.

EARTHING THE FENCE

The earthing component of the fence is very important. Without adequate earthing, the electrical circuit from the energizer will not be completed when the animal touches the fence and the animal will receive an ineffective shock. The pulse needs to flow from the animal through the soil or other earthing system back to the energizer. Generally when there is good soil moisture you require less additional earthing components on your fence. Earthing conditions can vary depending on the season and the type of soil.

TYPICAL FENCE WITH GOOD EARTHING

If your earthing conditions are good all year round, you will only need live wires on your fence (no earth wires), and a few earth spikes in the vicinity of the energizer.

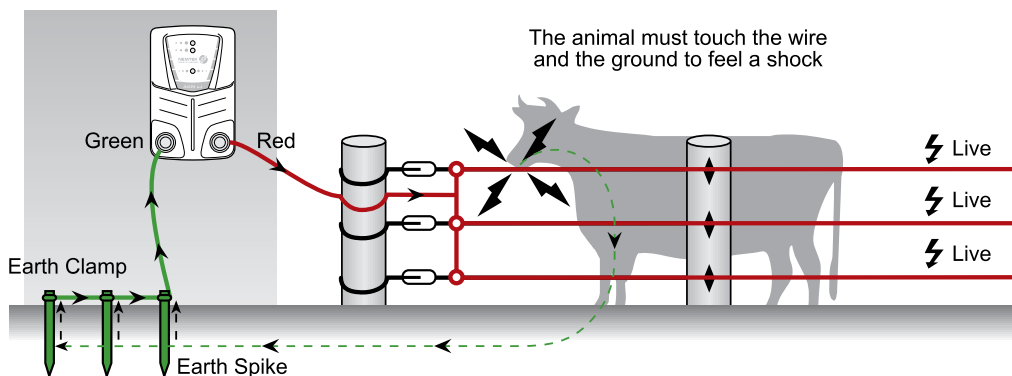

 LIVE WIRES AND CABLE  EARTH (GROUND) SYSTEM

TIPS FOR BETTER EARTHING

- Place your earth spikes in damp areas where possible.
- Earth spikes must be placed in the vicinity of the energizer. There should be at least three earth spikes, placed a minimum of two metres apart.
- The earth spike connectors (at the top of the earth spike) should always be visible for maintenance and ease of connection.
- Additional earth spikes can be connected to the earth wires of the electric fence. (Ensure that the earth wires are connected to the earth input of the energizer.)
- Earth spikes must be at least 10 metres away from electrical earth systems, e.g. house mains, telephone and power lines.

TYPICAL FENCE WITH INADEQUATE EARTHING

If you have inadequate earthing due to poor soil conditions or seasonal changes in the soil moisture levels, you will require additional earthing. You will need one or more earth wires along your fence in addition to your live wires. Earth spikes will also need to be placed along the fence. By introducing these additional earthing components, you counteract any bad soil conditions to ensure that the electrical circuit back to the energizer can be completed so that the animal receives an adequate shock.

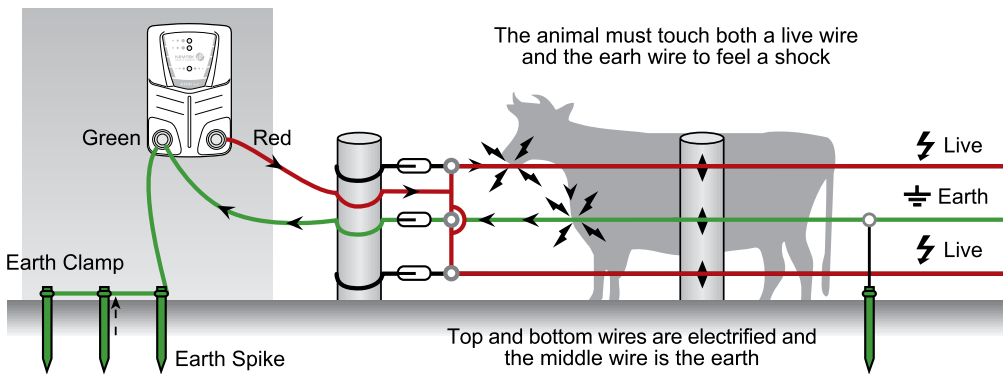

LIVE WIRES AND CABLE **EARTH (GROUND) WIRES AND CABLE**

TESTING THE EARTH SYSTEM

To ensure you have an adequate earth system, perform the following procedure according to these measurements: At least 100m away from the energizer earth spikes, drive an earth spike into the ground and short this spike to the fence live wires. Add additional earth spikes until the fence voltage at this point is reduced to 2 000V (2kV) or less. Using a Nemtek FenceScope (set to PROBE function) measure the voltage between the energizer earth spikes and an independent test earth spike driven into the ground one metre away. This test earth spike should be at least 800mm long. The reading, if any, should be below 300V.

If the measured voltage is greater, switch off the energizer and drive in additional earth spikes at the recommended spacing, and connect them to the existing earth system. Repeat this process until the measured voltage is reduced to an acceptable level.

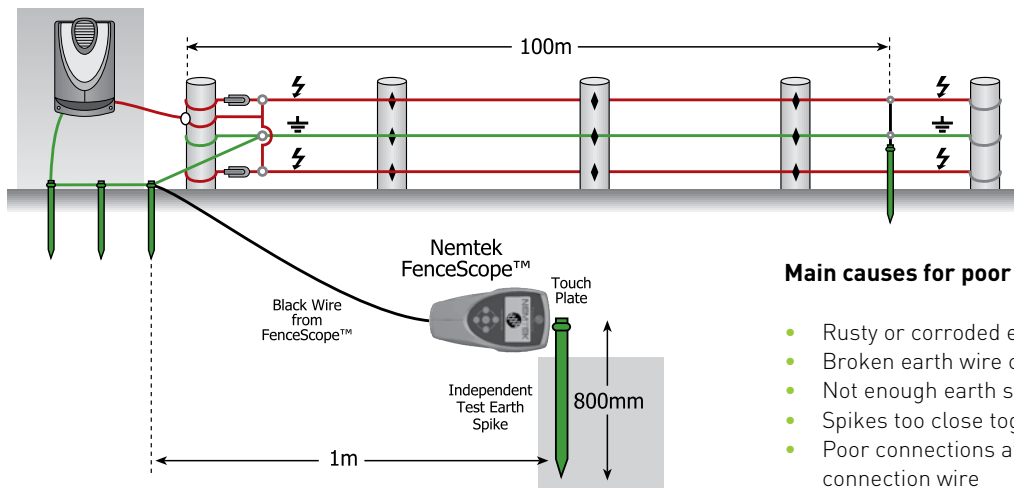

Main causes for poor earth are:

- Rusty or corroded earth spikes
- Broken earth wire connecting the spikes
- Not enough earth spikes
- Spikes too close together or too short
- Poor connections at the spikes or in the connection wire

LIVE WIRES AND CABLE **EARTH (GROUND) WIRES AND CABLE**

TYPES OF FENCES

Permanent electric fence

A permanent fence for game animals or livestock will require higher tensile strengths, be more robust, have a longer life span and use more durable insulators and equipment.

Animals tend to run into the fence before seeing it and they could damage the fence, especially in the dark.

1. Energizer
2. Earth spike
3. Strain insulator
4. Post insulator
5. Wire tensioner
6. Warning sign
7. Earth (green)
8. Live (red)
9. Strain post
10. Line post

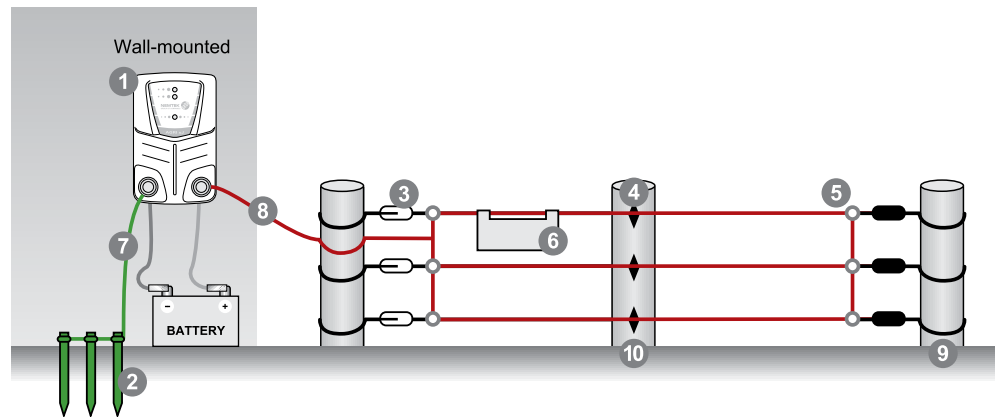

Portable electric fence

Portable fencing can be moved as required, creating temporary paddocks, strip-grazing areas, or even protecting flowerbeds and refuse areas from pets or feral animals.

The energizers are generally smaller units that can run for many days on battery power, or can be powered with solar cells and a battery back-up.

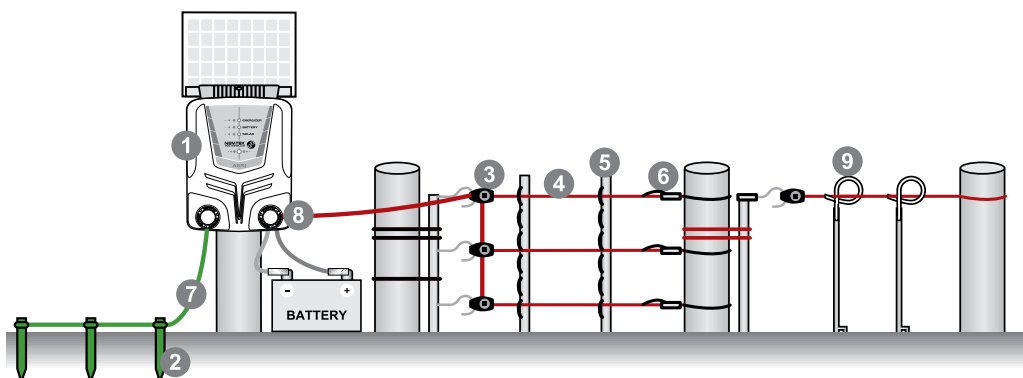

1. Energizer
2. Earth spike
3. Nylon wire tensioner
4. Polywire/polytape
5. Tread-in post
6. Insulated handle
7. Earth (green)
8. Live (red)
9. Pigtail post

 LIVE WIRES AND CABLE  EARTH (GROUND) WIRES AND CABLE

POST AND WIRE SPACING

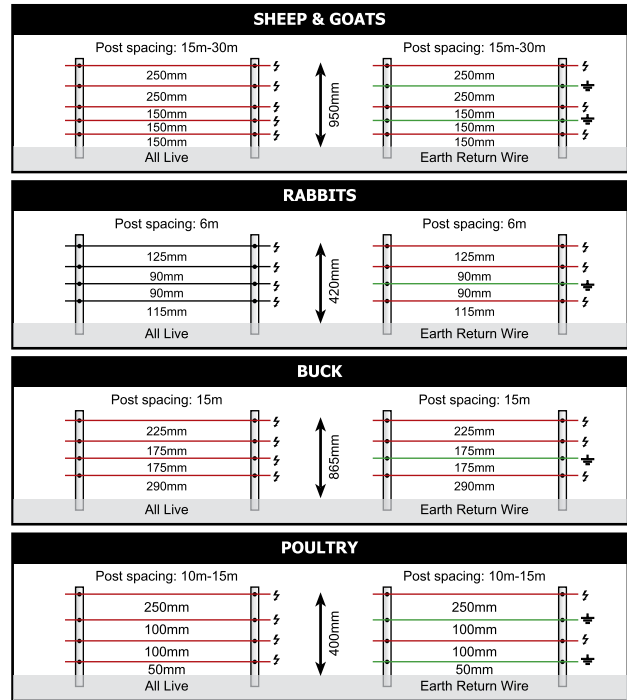
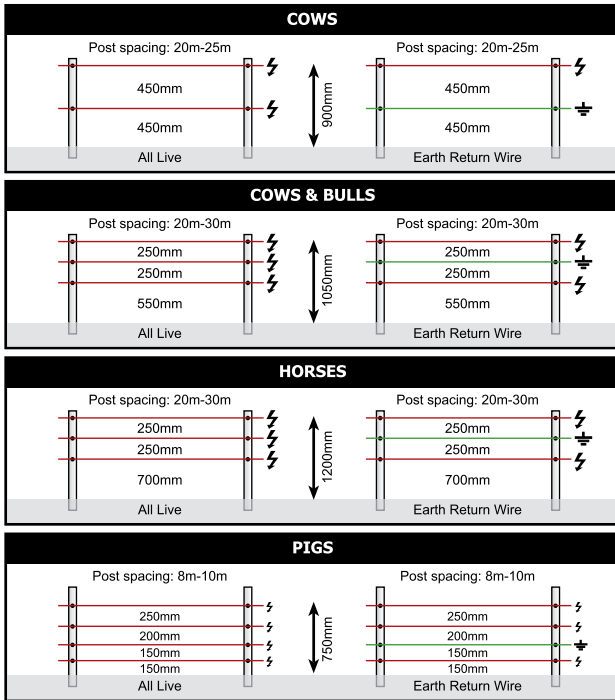

LIGHTNING AND SURGE PROTECTION

The lightning inhibitor and diverter can be used to reduce the likelihood of a power surge coming through the fence wires to the energizer as a result of lightning. It offers a two-pronged approach. First it inhibits the lightning surge from damaging the energizer, and second it diverts any lightning surge away from the energizer into the ground through the earth spikes. It can be mounted onto a flat or round surface.

Installation using an AGRI Energizer permanent fence

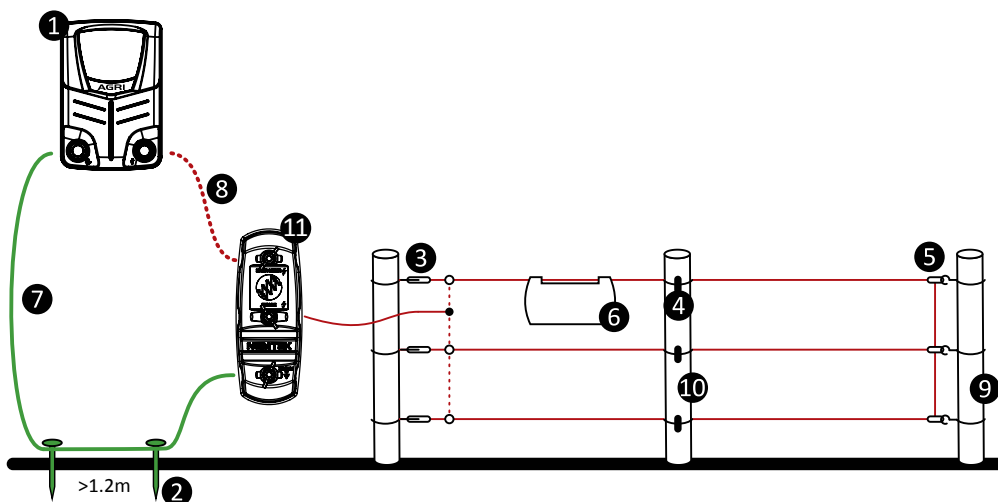

1. Energizer
2. Earth spike
3. Strain insulator
4. Intermediate insulator
5. Nylon wire tensioner
6. Nemtek warning sign
7. Earth (green)
8. Live (red)
9. Tension post
10. Intermediate post
11. Lightning inhibitor and diverter

FENCE FAULT-FINDING CHART

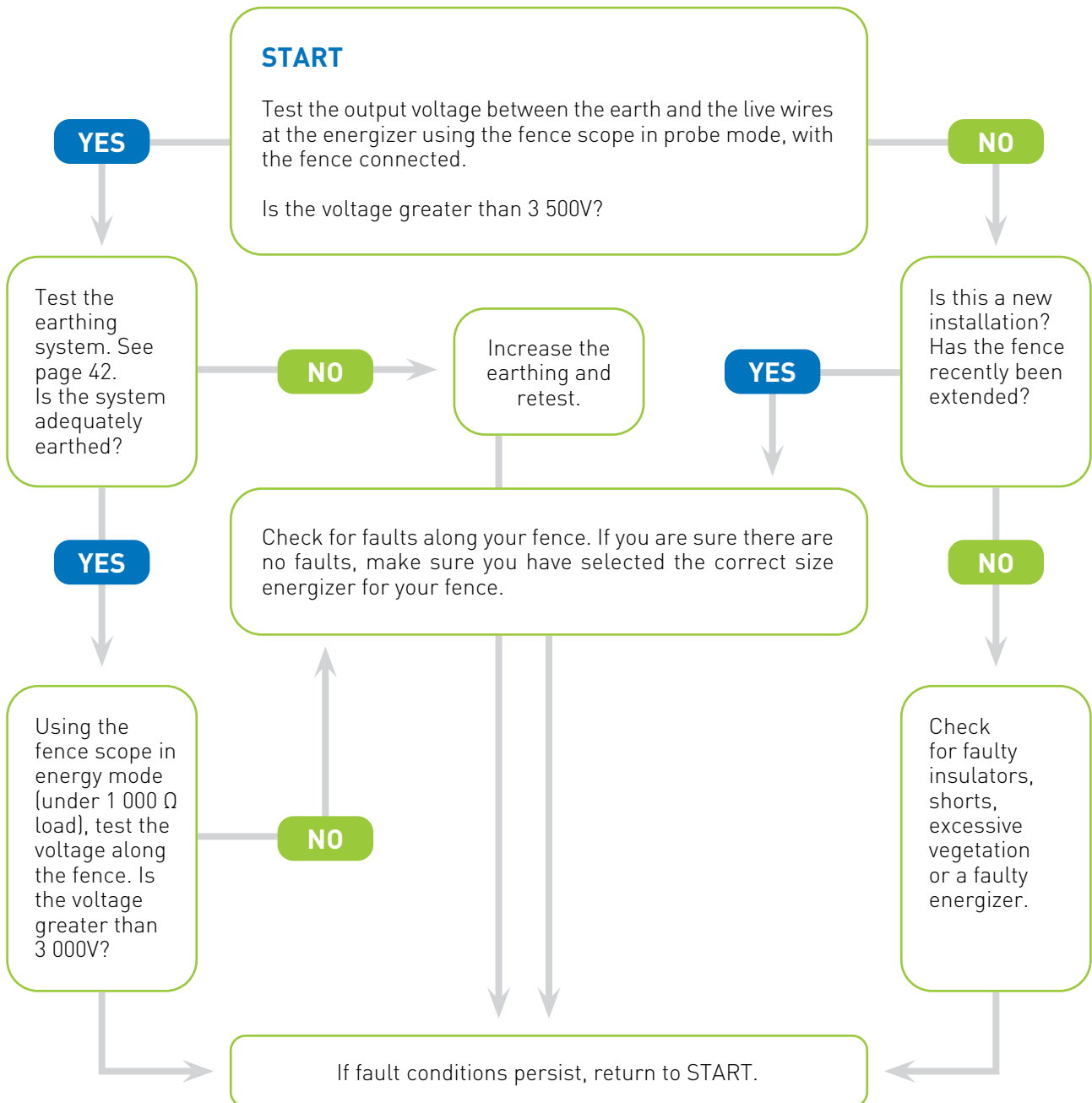

NEMTEK
Electric Fencing Products



CONTACT DETAILS

Head Office Northriding	Northriding Commercial Park, Stand 251 Aintree Avenue, Northriding, Randburg, South Africa Tel: +27 (0) 11 462 8283/4 Email: websales@nemtek.com
Exports	Northriding Commercial Park, Stand 251 Aintree Avenue, Northriding, Randburg, South Africa Tel: +27 (0) 11 462 8283/4 Email: exports1@nemtek.co.za
Edenvale	Unit 1 Meadowdale Office Park, Cnr Dick Kemp and Herman Road, Edenvale, South Africa Tel: +27 (0) 11 453 1970
Cape Town	21 Concord Crescent, Airport City, Cape Town, South Africa Tel: +27 (0) 21 386 3742/3100
Port Elizabeth	Unit 4, 51 Leadwood Crescent, Fairview, Port Elizabeth, South Africa Tel: +27 (0) 41 581 4130/4064
Pinetown	19 Henwood Road, Pinetown, KZN, South Africa Tel: +27 (0) 31 701 2125/3131
Nelspruit	46 Rapid Road, Riverside Industrial Park, Nelspruit, South Africa Tel: +27 (0) 13 752 2187
Upington	7 Vooruit Street, Building 5, Upington, South Africa Tel: +27 54 332 1338
Training	Northriding Commercial Park, Unit 6 Aintree Avenue, Northriding, Randburg, South Africa Tel: +27 (0) 11 462 1320 Email: trainingoffice@nemtek.com

www.nemtek.com